

# Everything You Need to Know About USB and Serial Interfaces

Presented by N6TV

[n6tv@arrl.net](mailto:n6tv@arrl.net)

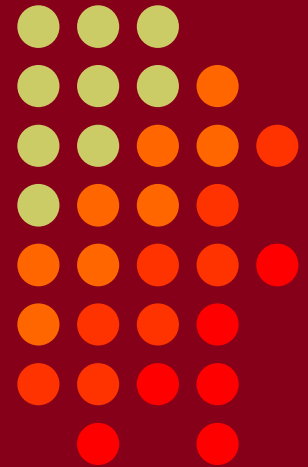

• CTU •  
CONTEST  
UNIVERSITY

ICOM®

# Presentation Overview



- Legacy PC Serial Ports
- USB Ports and Devices
- USB-to-Serial Adapters
- Using the Windows Device Manager
- Managing Serial Port Numbers
- Using Serial Ports for CW / FSK / PTT Keying
- Sharing Serial Ports
- USB Sound Cards
- Q & A

# Legacy PC Serial Ports



- Originally a 25-pin male D-SUB connector (DB-25M), used with dial-up modems
- Smaller 9-pin male serial connector became standard (DE-9M) for serial, DB-25F for printers

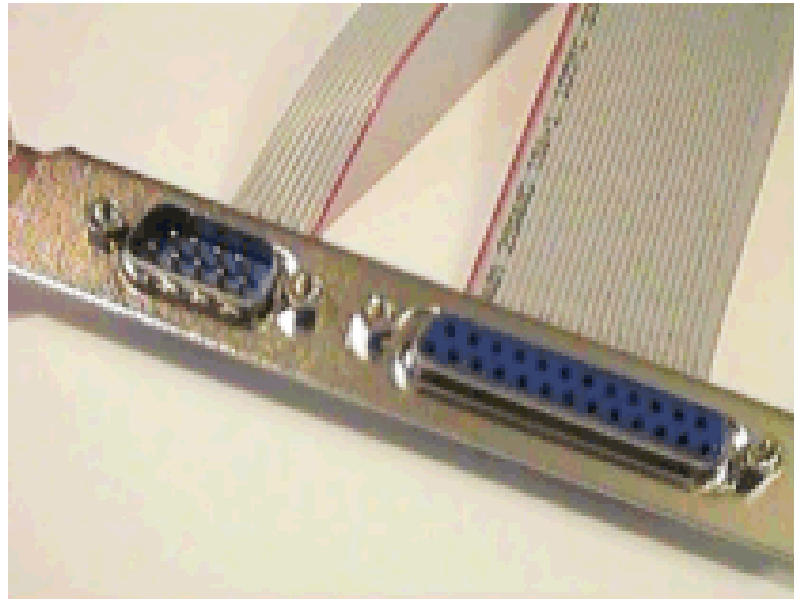

# Life was Simple



- One or two male DE-9 connectors on PC
- Accessed as COM1: or COM2:
- One DE-9 “CAT” or “RS232” connector on radio
  - Female: Elecraft IC-7700 & IC-7800



- Male: Yaesu



- Kenwood



# Computers “Improved”





- “Real” serial and parallel ports disappear, replaced by USB ports
- Notebook computers: PCMCIA, PC Card, ExpressCard slots for serial adapters disappear
- Radios (until recently) still had 9-pin serial ports
- Peripherals are still using 9-pin serial ports
  - RemoteRig boxes, Rotator controllers, SteppIR antenna controllers, some band decoders, etc.
- Common Solution: USB-to-Serial adapters



# USB 2.0 and 3.0 Ports

- Standard connector on most PCs and MACs

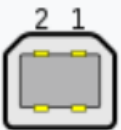
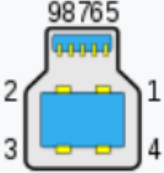
PC:	<p>Type A</p>  <p>1 2 3 4 Type-A</p>	<p>Type A</p>  <p>9 8 7 6 5 1 2 3 4 Type-A SuperSpeed</p>
Radio:	<p>Type B</p>  <p>2 1 3 4 Type-B</p>	<p>Type B</p>  <p>9 8 7 5 2 1 3 4 Type-B SuperSpeed</p>

# USB-to-Serial Adapters



- Reliability and Compatibility Varies Greatly
  1. Edgeport – Excellent, stable, supports MMTTY directly
  2. Eltima – Included with microHAM interfaces
  3. FTDI – very good, stable, requires EXTFSK for MMTTY. Used internally by Elecraft K3.
  4. Silicon Labs (built in to Icom, Kenwood, Yaesu)
  5. Prolific – **AVOID!** Uninstall drivers, recycle.



# Digi International Edgeport/4

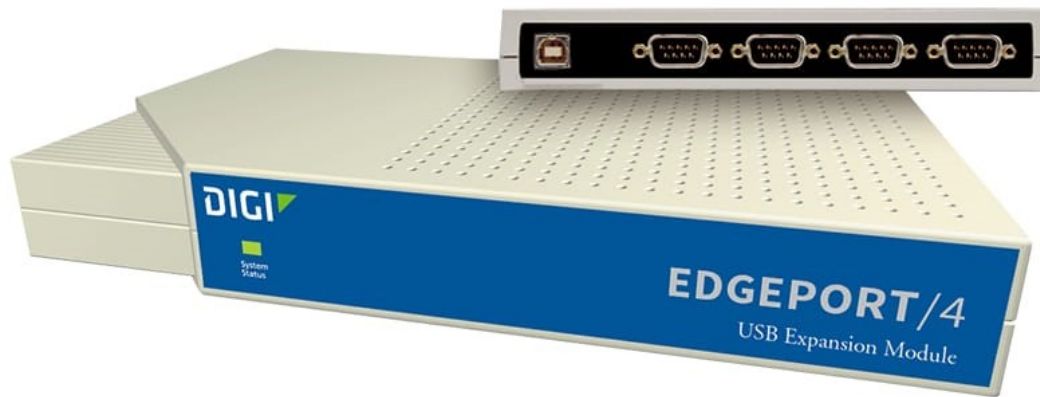

- One USB 2.0 Type B connector
- Four independent DE-9M serial ports
- Windows automatically finds and installs drivers





# Digi International Edgeport/8



- One USB 2.0 Type B connector
- Eight independent DE-9M serial ports
- Windows automatically finds and installs drivers

# StarTech.com ICUSB2324I 4-Port FTDI



- One USB 2.0 Type B connector
- Four independent FTDI DE-9M serial ports
- Separate 5V Power Supply

# StarTech.com ICUSB2328I 8-Port FTDI

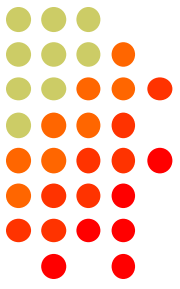

- One USB 2.0 Type B connector
- Eight independent FTDI DE-9M serial ports
- Separate 5V Power Supply

# microHAM uses Eltima drivers



## microHAM MK2R+



- One USB Type B connector
- Custom Eltima serial port device drivers
- Custom cables for transceiver ports
- Virtual serial ports created by microHAM “Router”



# Recommended FTDI USB-to-Serial Adapters

FTDI CHIP-10 - \$16



GearMo 2-port - \$30



GearMo 4-port - \$40



# Prolific USB-to-Serial Adapters



- Widely available, cheap (but many counterfeits)
- Prolific Device Driver does *not* play well with others
- Please DO NOT USE them, ever
- **Uninstall** any Prolific device drivers with Device Manager
- Devices often look like this:



# Connecting USB-to-Serial Adapters



- Connect FTDI, Elecraft, or Edgeport device to PC
- Windows (usually) locates and installs appropriate device driver(s)
- COM ports assigned sequentially
- Use Windows Device Manager to view assigned COM Port number

# Connecting USB Radios / Devices





- Important: Install the manufacturer's device driver first, *then* connect the device
  - Icom, Kenwood, Yaesu, microHAM
  - Usually not required for Elecraft (FTDI)
- If you forget and connect radio first, use Device Manager to uninstall “Unknown Device”, then start over
- COM port numbers assigned sequentially



# Using the Windows Device Manager



- **Right click** on Windows **Start Button** 
- **Click Device Manager**
- or-
- Windows Key  + R (Run): **devmgmt.msc**
- Important Tip (before Windows 10):  
Always set the System Environment Variable  
**devmgr\_show\_nonpresent\_devices** to 1

# Setting System Environment Variable

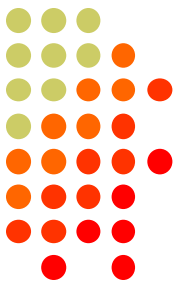

- Type “Environment” in Windows Search box or Windows Settings Search box



Windows Settings



- Click “Edit the System Environment Variables”

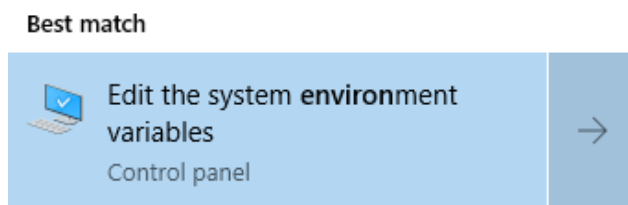

# Step 1 – Under Advanced tab click Environment Variables...

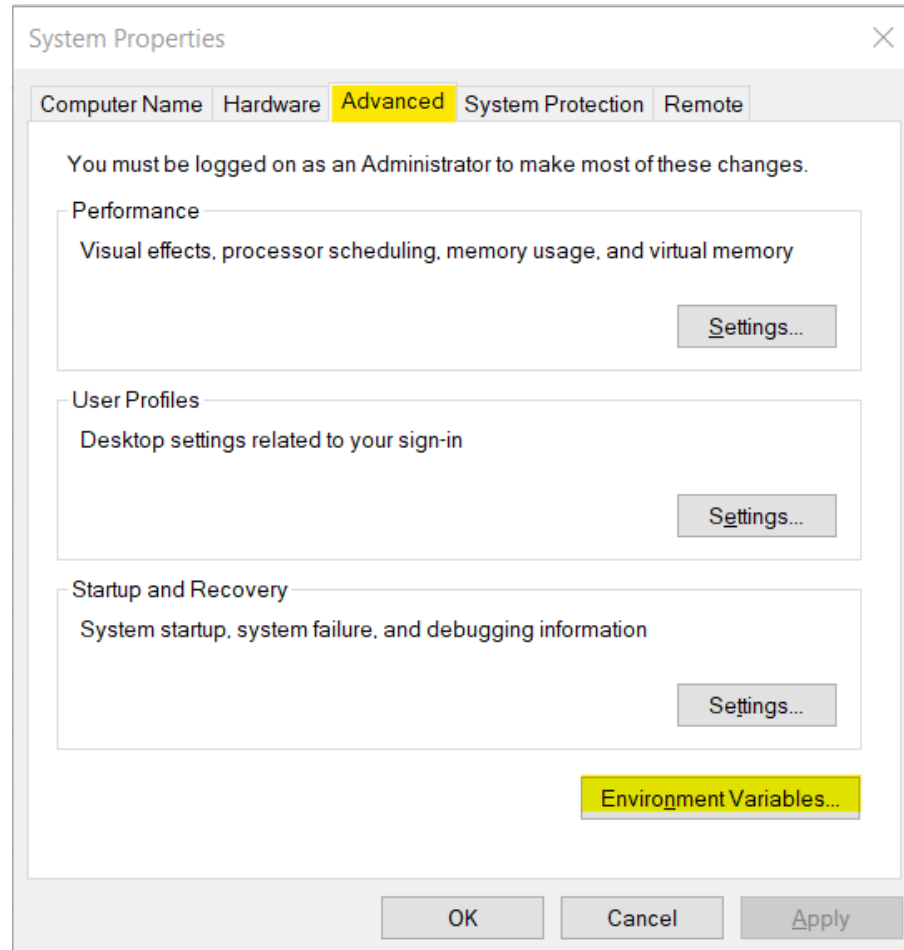

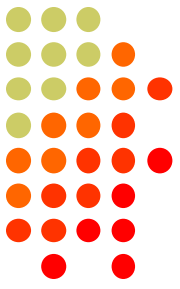

## Step 2 – Under System variables, click New...

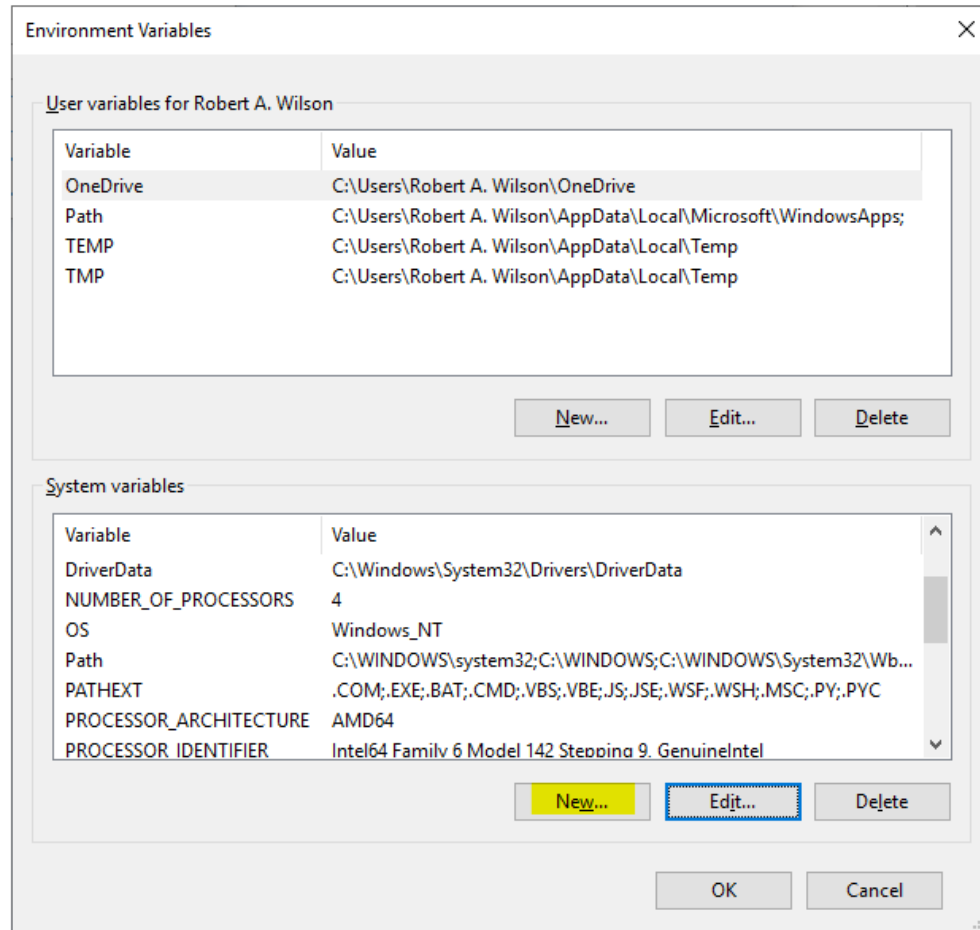



## Step 3 – Add the new environment variable

Name: `devmgr_show_nonpresent_devices`

Value: `1`

The screenshot shows a Windows dialog box titled "Edit System Variable". It has a close button (X) in the top right corner. The dialog contains two text input fields: "Variable name:" with the text "devmgr\_show\_nonpresent\_devices" and "Variable value:" with the text "1". Below the input fields are four buttons: "Browse Directory...", "Browse File...", "OK", and "Cancel". The "OK" button is highlighted with a blue border.

Click **OK**, then start Windows Device Manager

# Step 4 – in Device Manager (every launch): Select View → Show hidden devices

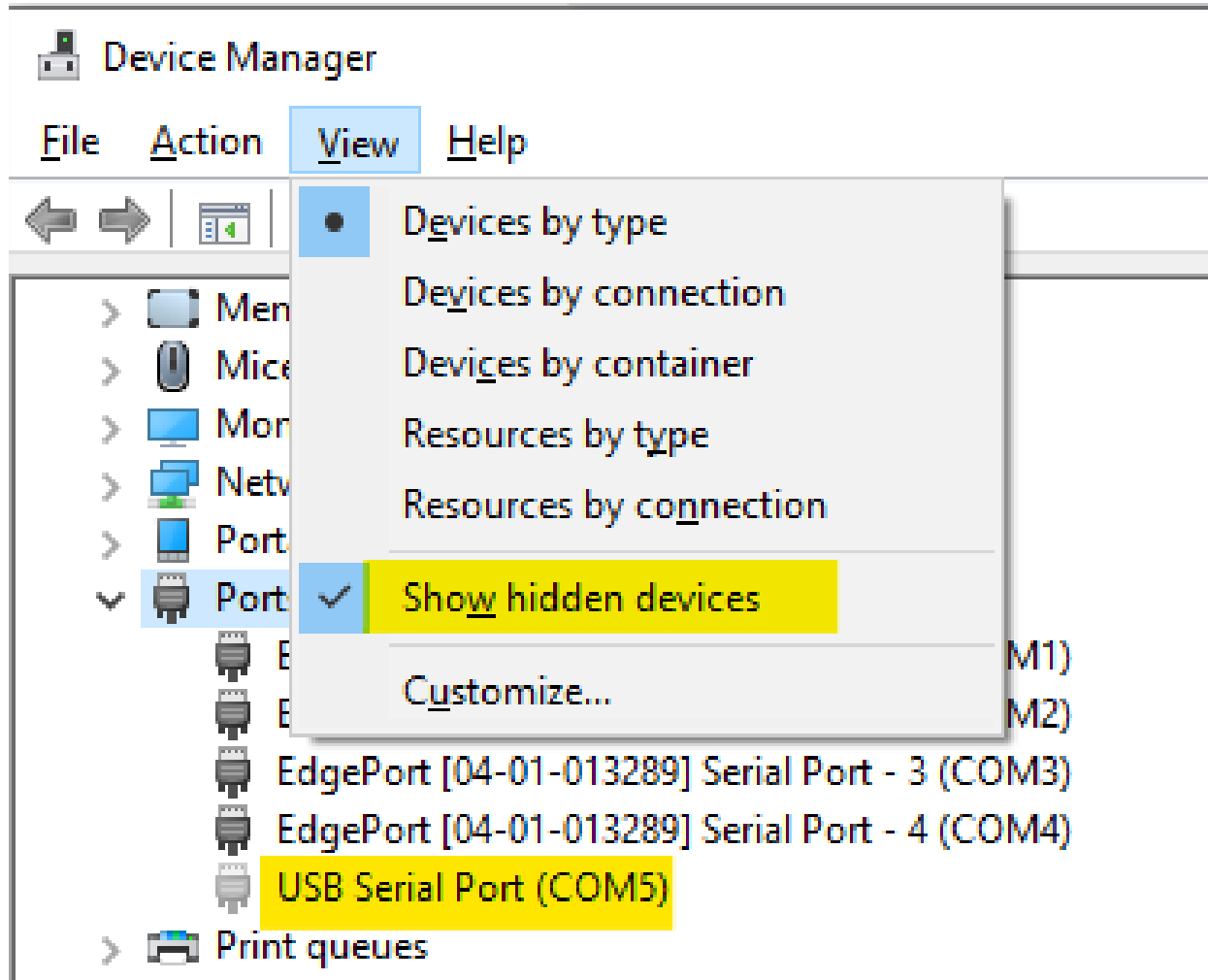

# Expand Ports section

Right click gray (offline) devices, Properties

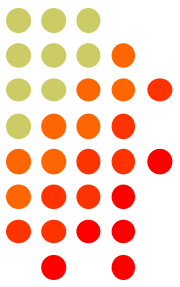

The screenshot shows the Windows Device Manager interface. The 'Ports (COM & LPT)' section is expanded, showing four 'EdgePort [04-01-013289] Serial Port' entries (COM1 to COM4) and one 'USB Serial Port (COM5)'. The 'USB Serial Port (COM5)' is highlighted in blue. A context menu is open over it, listing 'Update driver', 'Uninstall device', 'Scan for hardware changes', and 'Properties'. The 'Properties' option is highlighted in green.

- Ports (COM & LPT)
  - EdgePort [04-01-013289] Serial Port - 1 (COM1)
  - EdgePort [04-01-013289] Serial Port - 2 (COM2)
  - EdgePort [04-01-013289] Serial Port - 3 (COM3)
  - EdgePort [04-01-013289] Serial Port - 4 (COM4)
  - USB Serial Port (COM5)
- Print queues
- Printers
- Processors
- Security devices
- Smart card filters
- Smart card readers
- Software components

Context menu options:

- Update driver
- Uninstall device
- Scan for hardware changes
- Properties

# Click Driver Tab

## Check that Driver Provider is not Prolific

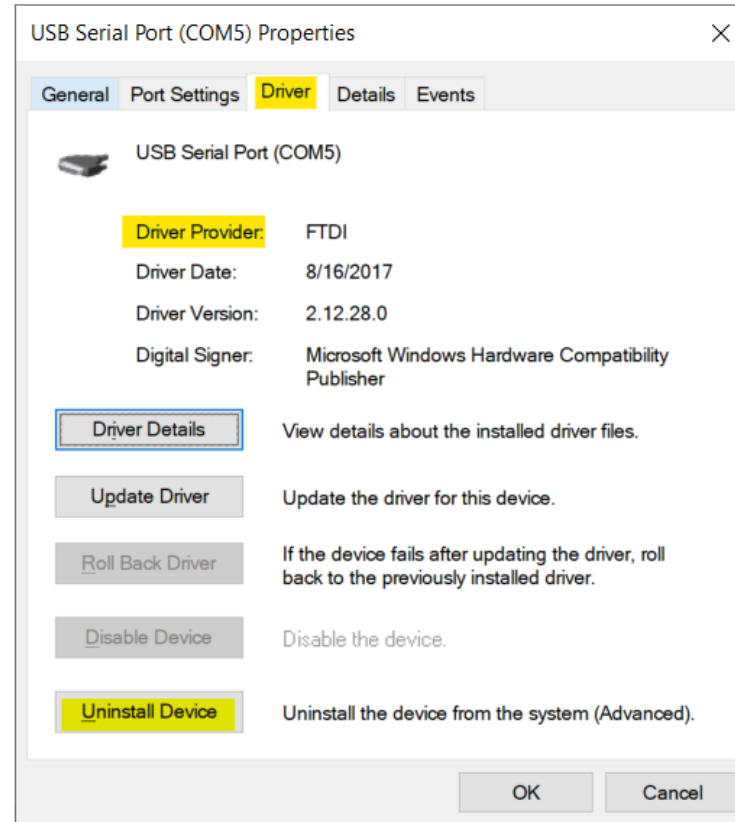
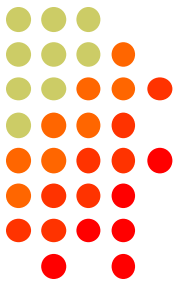

- If you see **Prolific**, click **Uninstall Device**



# Uninstall the Prolific Device *AND* Delete the Driver Software

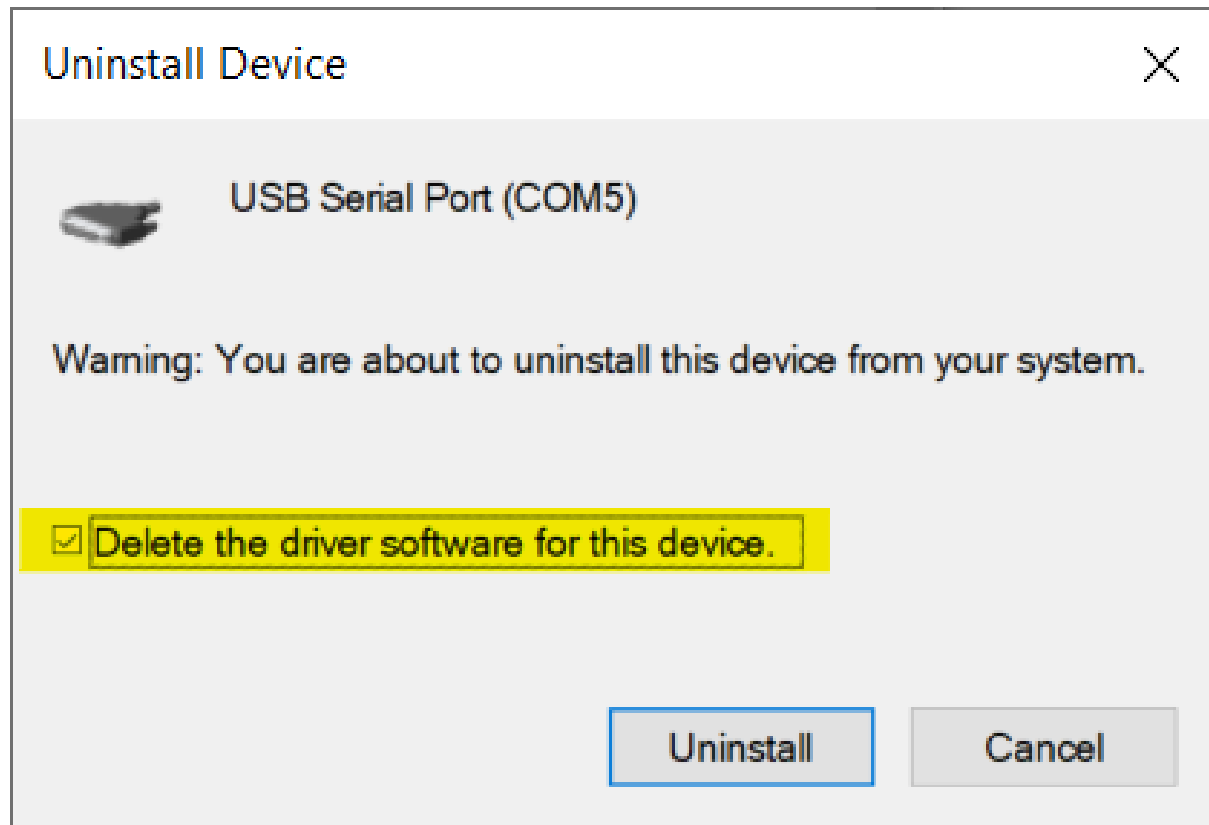
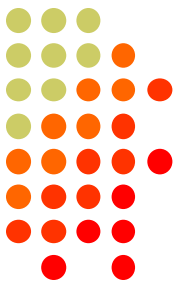

# If Driver is FTDI, go to Port Settings tab Click Advanced... button

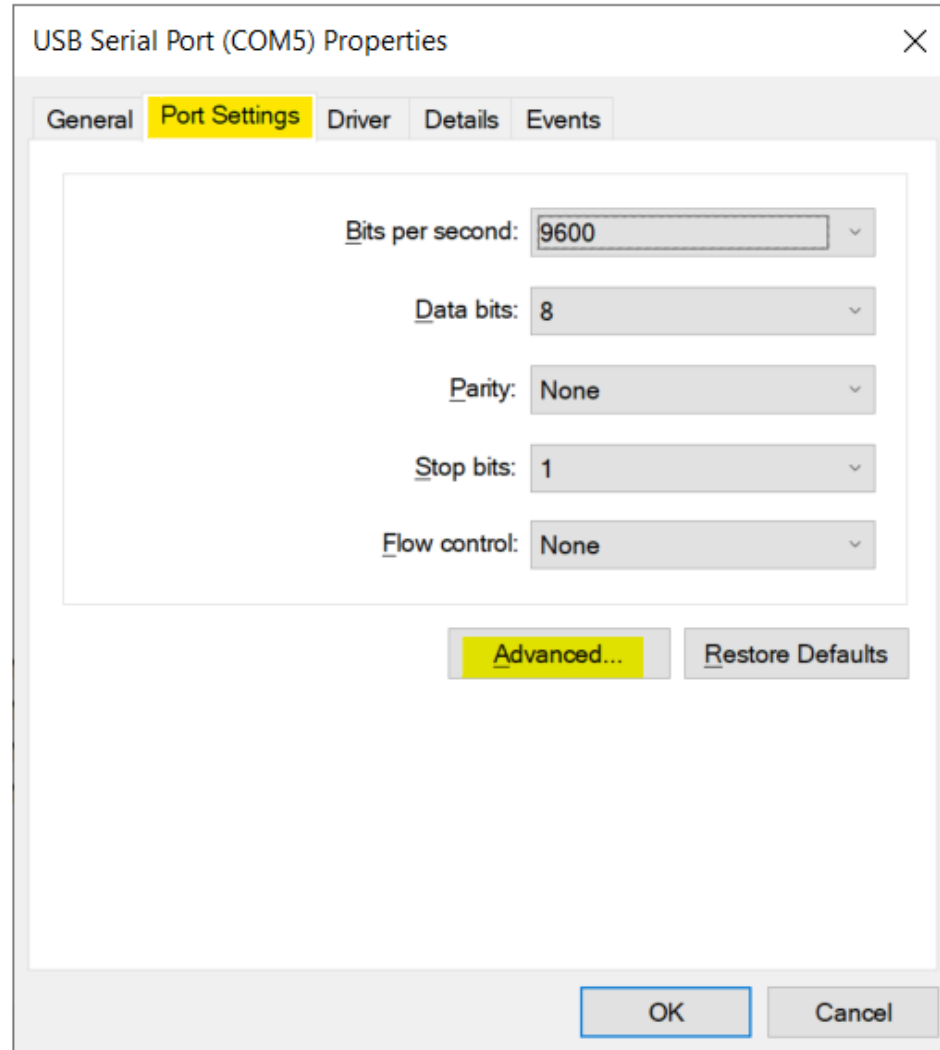

# FTDI Default Options – not good



Advanced Settings for COM5

COM Port Number: COM5

USB Transfer Sizes  
Select lower settings to correct performance problems at low baud rates.  
Select higher settings for faster performance.

Receive (Bytes): 4096

Transmit (Bytes): 4096

BM Options  
Select lower settings to correct response problems.

Latency Timer (msec): 16

Timeouts

Minimum Read Timeout (msec): 0

Minimum Write Timeout (msec): 0

Miscellaneous Options

- Serial Enumerator
- Serial Printer
- Cancel If Power Off
- Event On Surprise Removal
- Set RTS On Close
- Disable Modem Ctrl At Startup
- Enable Selective Suspend
- Selective Suspend Idle Timeout (secs): 5

OK  
Cancel  
Defaults

# Change the FTDI Options To This



Miscellaneous Options

Serial Enumerator	<input type="checkbox"/>
Serial Printer	<input type="checkbox"/>
Cancel If Power Off	<input type="checkbox"/>
Event On Surprise Removal	<input type="checkbox"/>
Set RTS On Close	<input type="checkbox"/>
Disable Modem Ctrl At Startup	<input checked="" type="checkbox"/>
Enable Selective Suspend	<input type="checkbox"/>
Selective Suspend Idle Timeout (secs):	5

# Under USB Serial Bus Controllers: Right-Click each, Select Properties

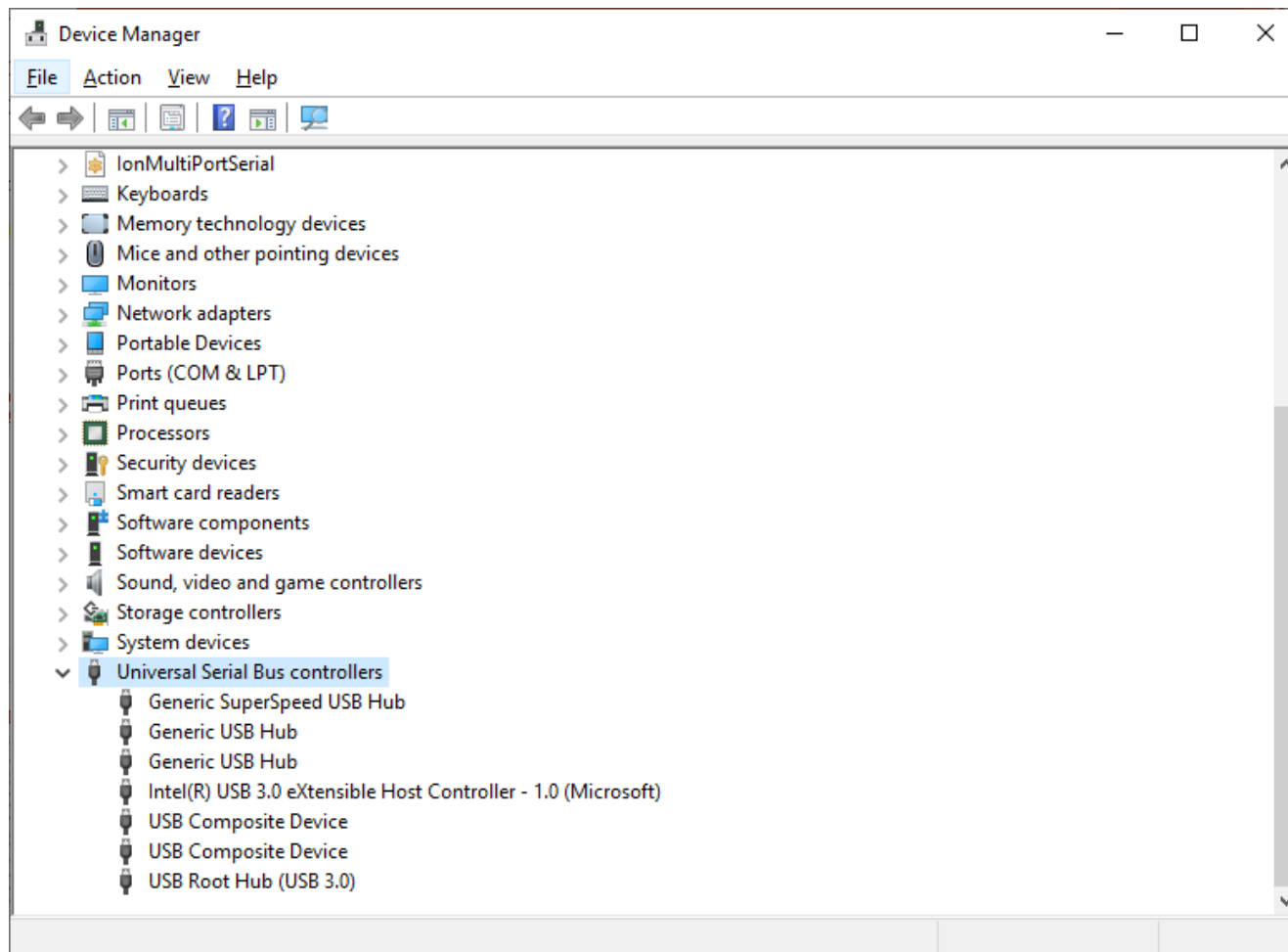

# Look for Power Management Tab

## Do not allow computer to turn off

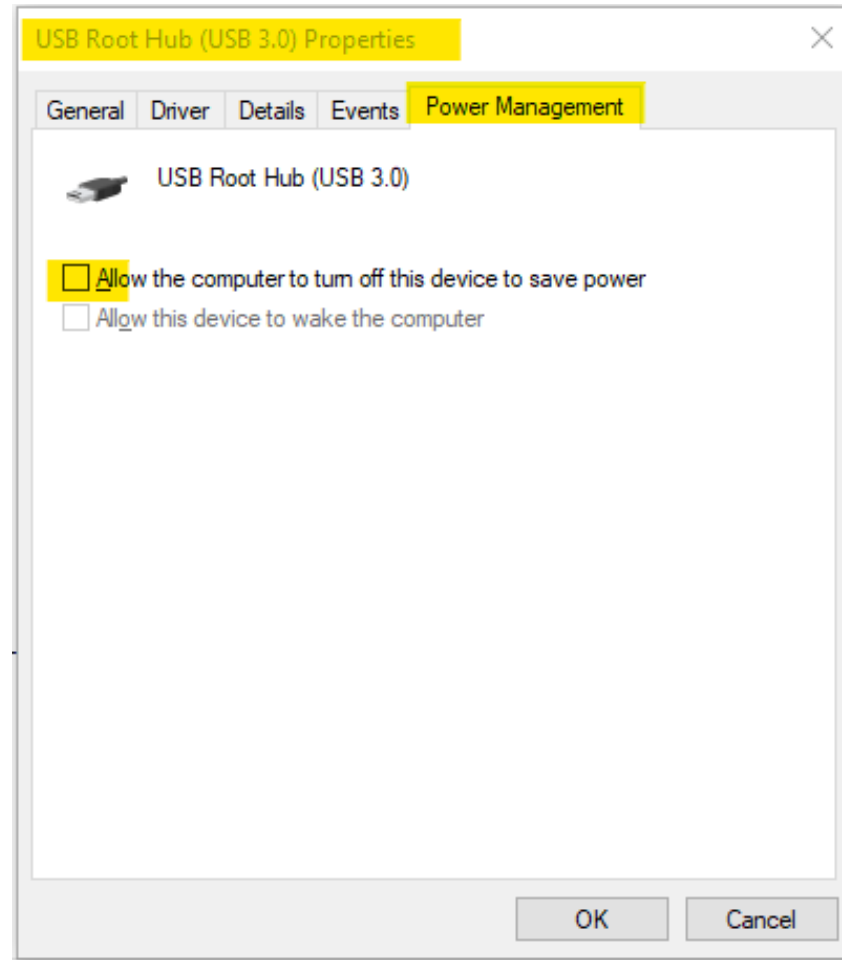
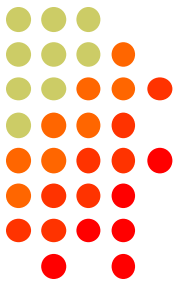

# Another USB Dev. Management Tool: NirSoft's USBDeview



- Stands for USB Device View
- [https://www.nirsoft.net/utils/usb\\_devices\\_view.html](https://www.nirsoft.net/utils/usb_devices_view.html)
- Scroll Way Down to the “Feedback” section to find download link:

## Feedback

If you have any problem, suggestion, comment, or you found a bug in my utility, you can send a message to [nirsofer@yahoo.com](mailto:nirsofer@yahoo.com)

[Download USBDeview](#)

[Download USBDeview for x64 systems](#)

# USBDeview Screen Shot



Device Name	Description	Device Type	Connected	Saf...	Dis...	US...	D..	Serial Number	Created Date	Last Plug/Unplug Date
0000.0014.0000.001.000.000.000.000.000	USB Input Device	HID (Human Interface Device)	No	Yes	No	No			5/7/2020 11:00:47 PM	5/7/2020 11:00:47 PM
0000.0014.0000.001.000.000.000.000.000	USB Audio Device	Audio	No	Yes	No	No			5/7/2020 11:00:47 PM	5/7/2020 9:51:37 PM
Port_#0001.Hub_#0001	USB Composite Device	Unknown	No	Yes	No	No			5/7/2020 11:00:47 PM	5/7/2020 9:51:37 PM
Port_#0001.Hub_#0001	OLYMPUS E-M1 USB Device	Mass Storage	No	Yes	No	No	E:	BHP250024	5/6/2020 9:09:11 PM	5/6/2020 9:09:11 PM
Port_#0001.Hub_#0001	SanDisk U3 Cruzer Micro U...	Mass Storage	No	Yes	No	No		4317130EE50...	5/2/2020 5:21:59 PM	5/2/2020 5:21:59 PM
Port_#0001.Hub_#0001	USB Serial Converter	Vendor Specific	No	Yes	No	No		FT0F52FP	5/1/2020 1:39:05 PM	5/1/2020 1:39:05 PM
USBPS2	USB Input Device	HID (Human Interface Device)	Yes	Yes	No	No			4/24/2020 3:44:22 PM	4/24/2020 3:44:22 PM
USBPS2	USB Input Device	HID (Human Interface Device)	Yes	Yes	No	No			4/24/2020 3:44:22 PM	4/24/2020 3:44:22 PM
Port_#0001.Hub_#0001	USB Serial Converter	Vendor Specific	No	Yes	No	No		FT2014DO	4/18/2020 12:03:29 PM	4/18/2020 12:03:29 PM
Port_#0001.Hub_#0001	USB Serial Converter	Vendor Specific	No	Yes	No	No		FT2018BX	4/18/2020 11:50:49 AM	4/18/2020 11:50:49 AM
Port_#0013.Hub_#0001	USB Attached SCSI (UAS) ...	Mass Storage	No	No	No	No		MSFT30NA4B...	4/15/2020 11:11:37 PM	4/15/2020 11:11:37 PM
Port_#0001.Hub_#0001	OLYMPUS E-M1 USB Device	Mass Storage	No	Yes	No	No		BHP266099	5/3/2020 5:00:20 PM	4/4/2020 4:52:19 PM
0000.0014.0000.006.000.000.000.000.000	USB Input Device	HID (Human Interface Device)	No	Yes	No	No			3/2/2020 7:32:26 AM	3/2/2020 7:32:26 AM
0000.0014.0000.006.000.000.000.000.000	USB Input Device	HID (Human Interface Device)	No	Yes	No	No			3/2/2020 7:32:26 AM	3/2/2020 7:32:26 AM
Port_#0001.Hub_#0001	Sony Storage Media USB D...	Mass Storage	No	Yes	No	No		0905092114695	9/8/2019 8:24:07 AM	9/8/2019 8:24:07 AM
0000.0014.0000.006.000.000.000.000.000	Remote NDIS based Interne...	Remote NDIS	No	Yes	No	No			3/2/2020 7:32:26 AM	9/5/2019 11:45:14 AM
Port_#0006.Hub_#0001	USB Composite Device	Unknown	No	Yes	No	No		UML2956995...	3/2/2020 7:32:26 AM	9/5/2019 11:45:14 AM
Port_#0003.Hub_#0003	USB Printing Support	Printer	No	Yes	No	No		NKO2104051...	5/3/2020 10:59:09 PM	7/16/2019 6:16:58 PM
Edgeport/4	Edgeport/4	Vendor Specific	Yes	Yes	No	No		04-01-013289	4/24/2020 3:44:23 PM	7/15/2019 10:24:11 AM
0000.0014.0000.008.000.000.000.000.000	Integrated Camera	Video	Yes	Yes	No	No			4/24/2020 3:44:22 PM	7/15/2019 10:24:10 AM
Port_#0005.Hub_#0001	Alcor Micro USB Smart Car...	Smart Card	Yes	Yes	No	No			4/24/2020 3:44:21 PM	7/15/2019 10:24:09 AM
Port_#0007.Hub_#0001	Intel(R) Wireless Bluetooth(...	Bluetooth Device	Yes	Yes	No	No			4/30/2020 5:41:44 AM	7/15/2019 10:24:08 AM
Port_#0009.Hub_#0001	Synaptics WBDI	Vendor Specific	Yes	No	No	No		35d084ed148a	7/15/2019 10:24:08 AM	7/15/2019 10:24:07 AM
Port_#0004.Hub_#0001	Generic USB Hub	Unknown	Yes	Yes	No	No			4/24/2020 3:44:21 PM	7/15/2019 10:23:22 AM
Port_#0004.Hub_#0003	Generic USB Hub	Unknown	Yes	Yes	No	No			4/24/2020 3:44:22 PM	7/15/2019 10:23:22 AM
Port_#0008.Hub_#0001	USB Composite Device	Unknown	Yes	Yes	No	No			4/24/2020 3:44:21 PM	7/15/2019 10:23:22 AM
Port_#0016.Hub_#0001	Generic SuperSpeed USB H...	Unknown	Yes	Yes	No	No			4/24/2020 3:44:20 PM	7/15/2019 10:23:22 AM
USB-PS/2 Optical Mouse	Logitech USB Wheel Mouse	HID (Human Interface Device)	Yes	Yes	No	No			4/24/2020 3:44:22 PM	7/15/2019 10:23:22 AM
USBPS2	USB Composite Device	Unknown	Yes	Yes	No	No			4/24/2020 3:44:22 PM	7/15/2019 10:23:22 AM



# Managing COM Port Numbers



- Over time, ever increasing unique COM port numbers are assigned by Windows, difficult to keep track
- Some software doesn't support COM13: or higher
- Suggestion: renumber serial ports "left to right" to match your station layout, starting with transceivers
- First, use Windows Device Manager to uninstall all serial devices that you no longer use
- Right click on remaining COM ports, Properties, **Port Settings** tab. Click **Advanced...** button
- Renumber ports sequentially, COM3:, COM4:, COM5:, etc., "left to right"

# Renumbering Serial Ports

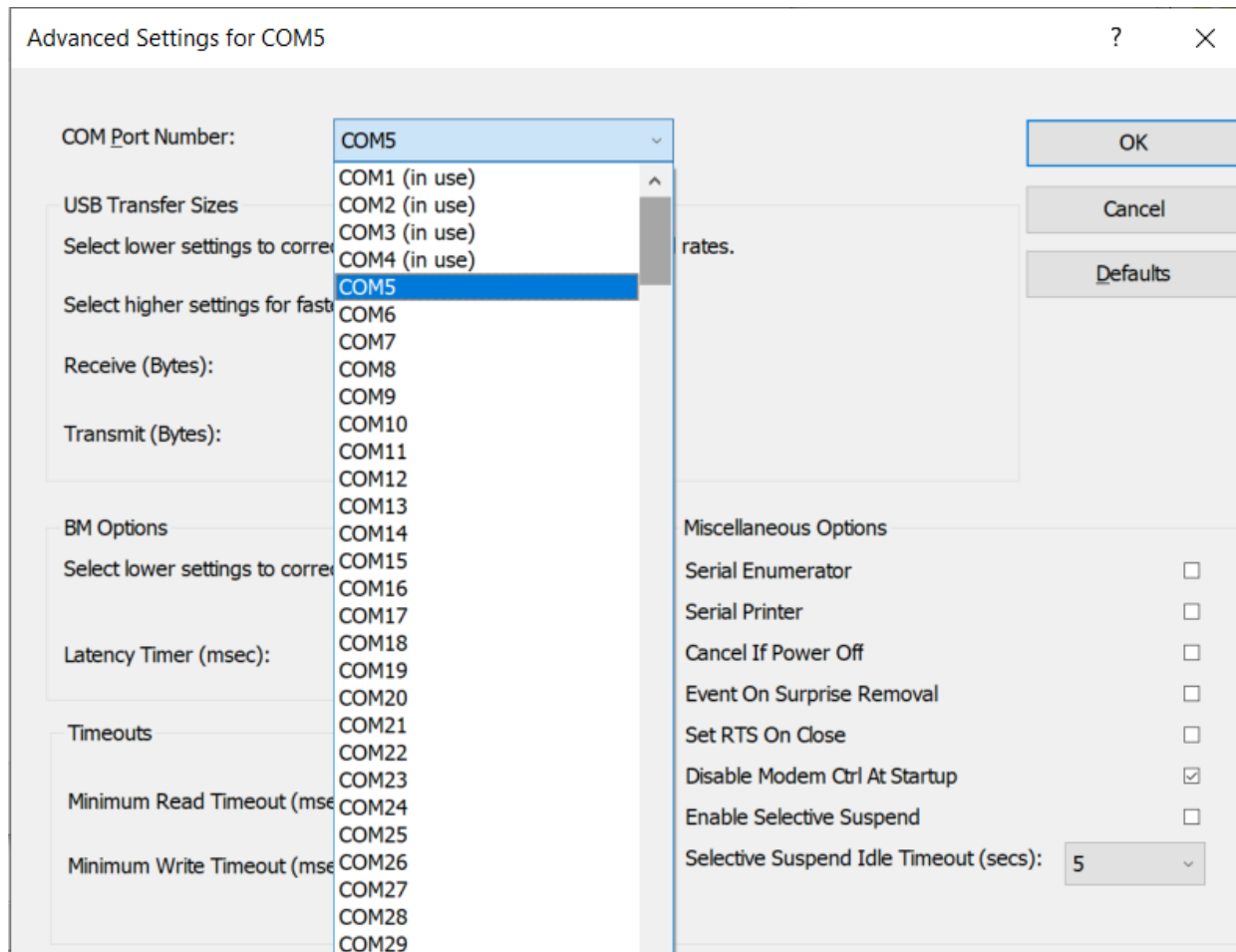



# What does “In Use” Mean?

- It means this COM port number was assigned to some device, maybe years ago
- It usually does *not* mean that you can't use it during reassignment, especially if it is “grayed out” (hidden)
- Uninstalling disconnected devices first will help
- *Usually* safe to ignore this warning and click YES:

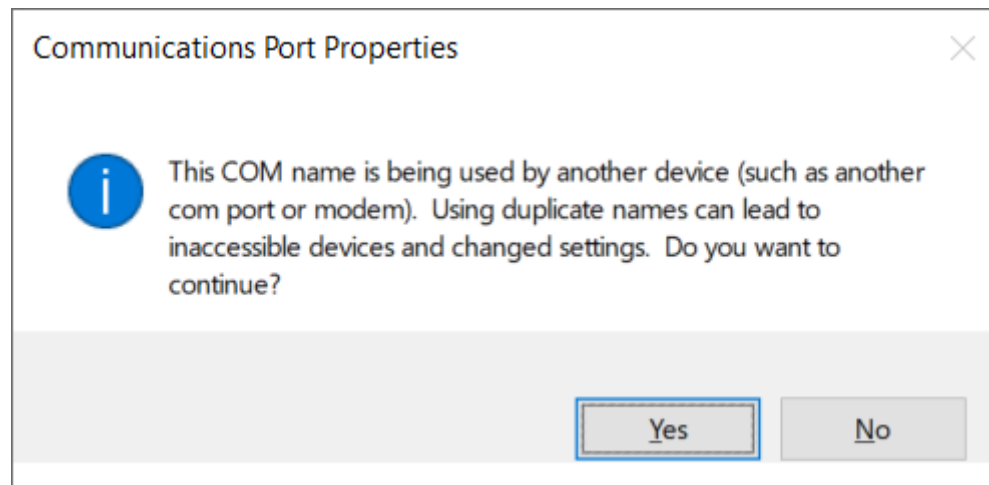

# What program is currently using my serial port?



- Use Windows Process Explorer
- <https://docs.microsoft.com/en-us/sysinternals/downloads/process-explorer>
- On Windows 10, run **procexp64.exe** as **Administrator**
- Click Search button (binoculars icon)
- Enter one of the following partial search strings
  - \Device\VCP** - FTDI virtual serial ports
  - \Device\Edg** - Edgeport virtual serial ports
  - \Device\Ser** - Hardware serial ports
  - \Device\Sil** - Icom/Kenwood/Yaesu Silicon Labs ports
  - \Device\VSer** – Eltima / vspMgr virtual serial ports

# Search Example 1

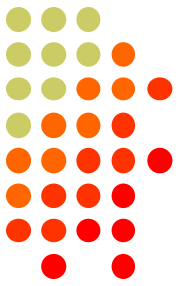

Process Explorer - Sysinternals: www.sysinternals.com [BOBX270\Robert A. Wilson] (Administrator)

File Options View Process Find Handle Users Help

Process	CPU	Private Bytes	Working Set	PID	Description
csrss.exe	0.22	2,752 K	6,888 K	728	Client Server Runtime Process
winlogon.exe		2,676 K	11,816 K	1116	Windows Logon Application

Process Explorer Search

Handle or DLL substring:

Process	PID	Type	Name
wt.exe	3832	File	\Device\VCP0

Win-Test (wt.exe) has opened the FTDI Serial Port

# Search Example 2

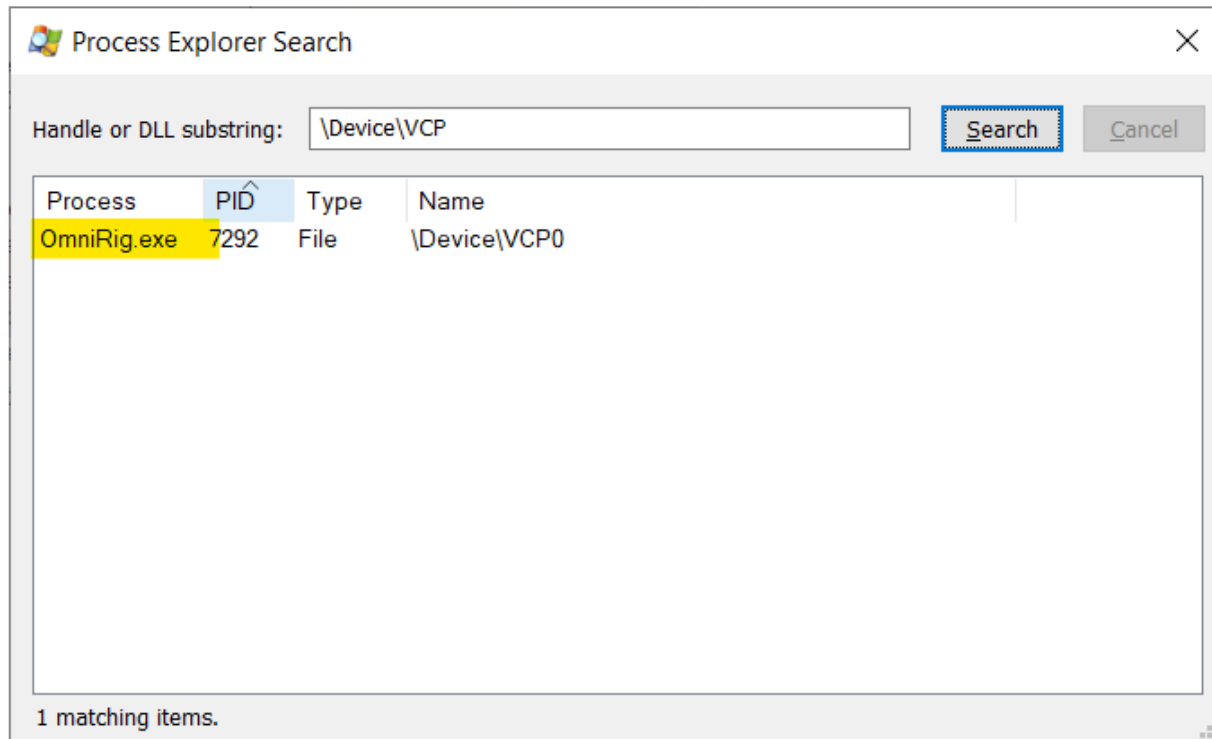

OmniRig (e.g. WSJT-X, Log4OM) has opened the FTDI Serial Port



# Not sure what to search for?

- Open a program known to use a particular serial port
- In Process Explorer, *drag* the “Find Windows Process” icon on top of the program window

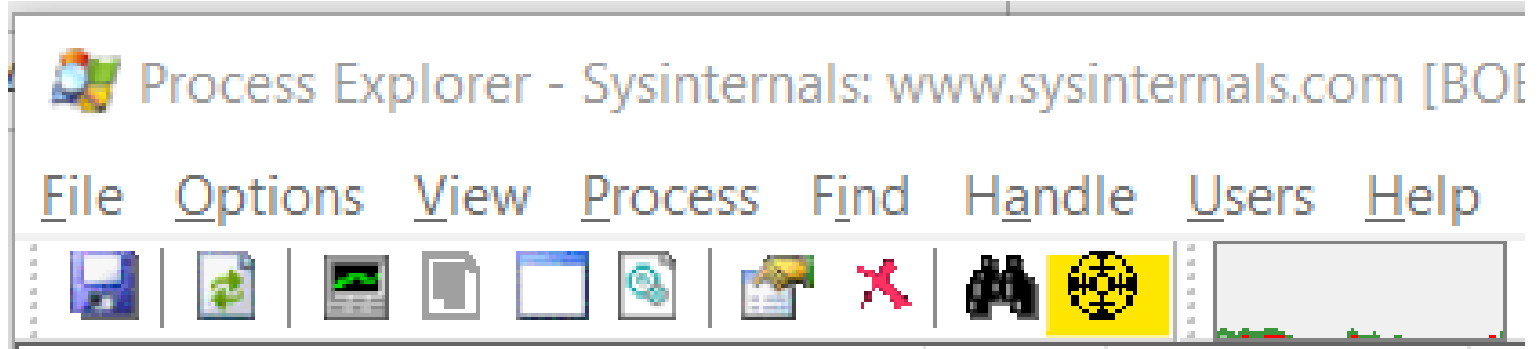

- Process Explorer will jump to the process corresponding to that program window

# Select View, Lower Pane View, Handles, then sort by Name

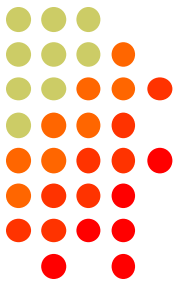

Process Explorer - Sysinternals: www.sysinternals.com [BOBX270\Robert A. Wilson] (Administrator)

File Options **View** Process Find Handle Users Help

Process

- winlogon.exe
- fontdrv...
- dwm.exe
- explorer.exe
- Security...
- WzPreloa...
- cmd.exe
- conhost...
- procexp...
- wt.exe
- Snipping...
- mspair...
- chrome...

Type

- Desktop
- File
- File
- File
- File
- File
- File
- File
- File
- File
- Event
- Directory
- Directory
- Directory
- Directory
- ALPC Port
- Directory

System Information... Ctrl+I

Show Process Tree Ctrl+T

Show Column Heatmaps

Scroll to New Processes

Show Unnamed Handles and Mappings

Show Processes From All Users

Opacity >

Show Lower Pane Ctrl+L

Lower Pane View >

- DLLs Ctrl+D
- Handles Ctrl+H

Refresh Now F5

Update Speed >

Organize Column Sets...

Save Column Set...

Load Column Set

Select Columns...

PID	Description	Company Name
1116	Windows Logon Application	Microsoft Corporation
1172	Usermode Font Driver Host	Microsoft Corporation
1248	Desktop Window Manager	Microsoft Corporation
7544	Windows Explorer	Microsoft Corporation
10476	Windows Security notification ...	Microsoft Corporation
12876	WinZip Preloader	WinZip Computing, S.L.
10552	Windows Command Process...	Microsoft Corporation
10840	Console Window Host	Microsoft Corporation
11236	Paint	Microsoft Corporation
12820	Google Chrome	Google Inc.
7272	Google Chrome	Google Inc.

CPU Usage: 7.10% Commit Charge: 28.77% Processes: 210 Physical Usage: 31.98%



# Computer CW, PTT, and FSK RTTY Keying Using Serial Port pins (DTR=CW, RTS=PTT)



- A simple hardware keying circuit, used for decades:

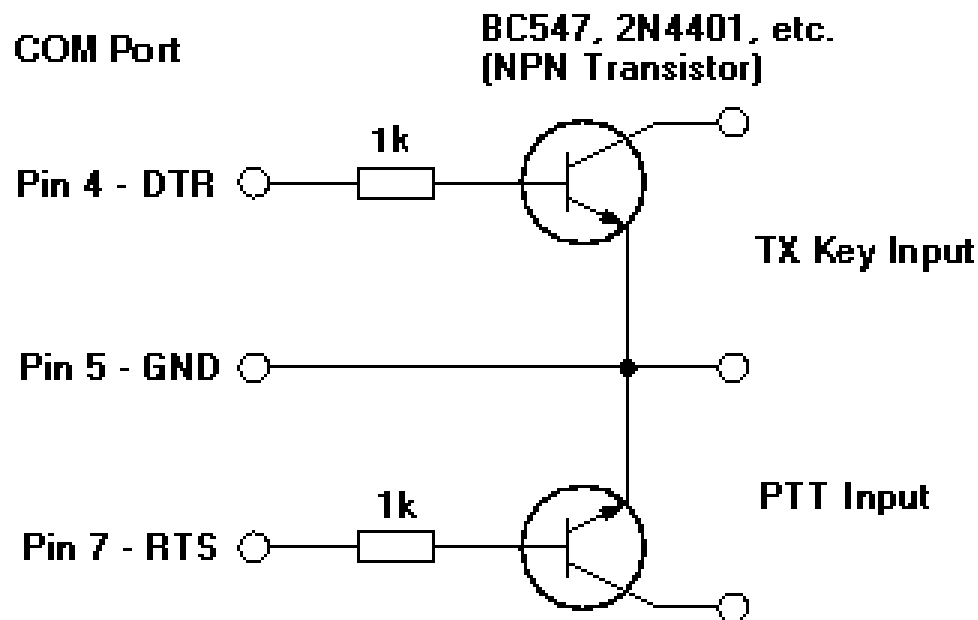



# Elecraft K3 / K3S keying via serial port

- First transceiver to include computer keying circuit *inside the radio*
- Does not use RTS and DTR pins for RS232 “Handshaking”, freeing them for other purposes
- In K3, set **CONFIG:PTT-KEY** to **RTS-DTR** (vs. **OFF-OFF**)
- Works the same over a standard serial cable (CONFIG:RS232 = 38400)  
-or- the K3S USB connection (CONFIG:RS332 = USB)
- To prevent unwanted transmissions when PC reboots, change FTDI Port Settings:
  - Uncheck “Serial Enumerator”
  - Check “Disable Modem Ctrl At Startup”



# ICOM Copies Elecraft, Adds FSK Keying

- CW, PTT, and FSK keying OK over USB virtual serial port
- Supported by IC-7300, IC-7610, IC-7850, IC-7851
- IC-7300 generates just one virtual serial port
- IC-7610, IC-7850, IC-7851 generate *two* virtual serial ports:

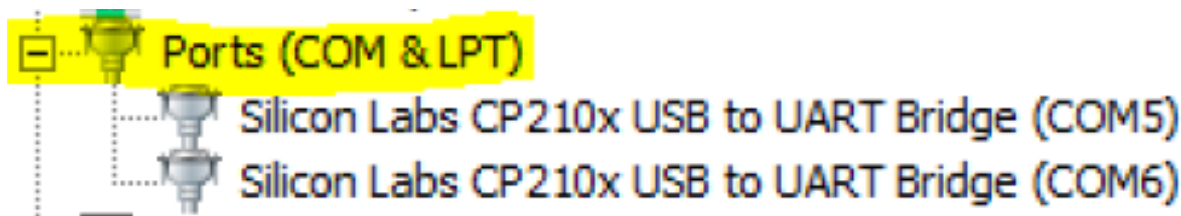

- To keep it simple use DTR pin for keying, RTS pin for PTT
- Use port “B” for MMTTY exclusively
- Mnemonic: CW : DTR : FSK • PTT : RTS : Send



# ICOM: Determining COM Port A and B

- Use Windows Device Manger, right click on first COM port, Properties, Details tab, Device Instance Path, check last letter

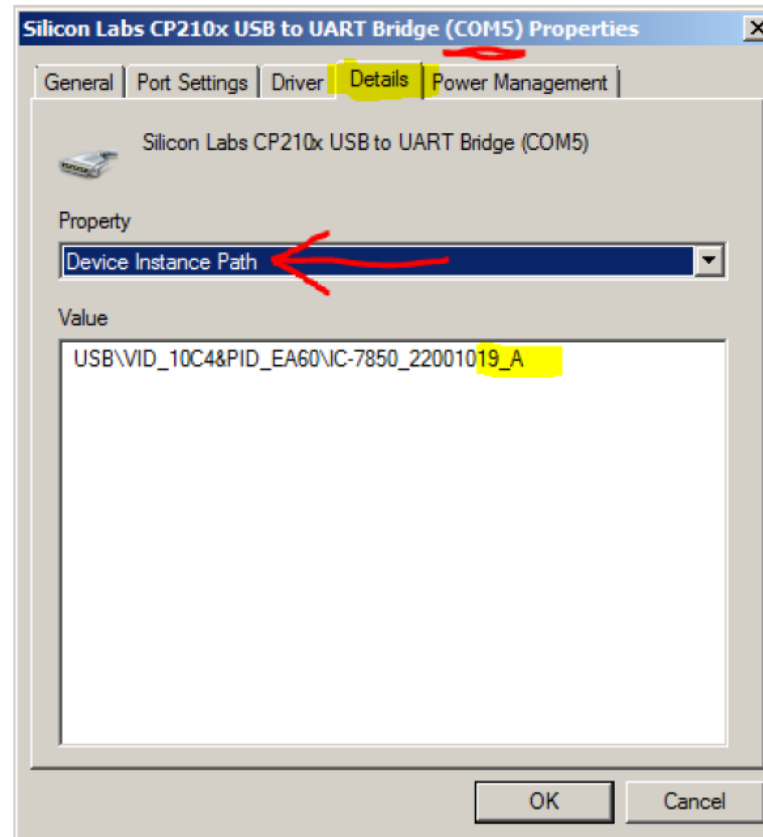



# ICOM IC-7300

- USB cable provides *one* virtual serial port
- In IC-7300 **SET > Connectors** menu:  
Set **USB Keying (CW)** to **DTR**  
-or-  
Set **USB Keying (RTTY)** to **DTR**
- Set **USB Send** to **RTS**
- Logging Software, rig control Port (USB), set DTR=CW,  
RTS=PTT
- In MMTTY, use **EXTFSK** or **EXTFSK64** to select COM port.
- **Cannot use logger at same time; rig has just one serial port.**  
But you can use the REMOTE (CI-V) connector with CT-17 or  
equivalent for rig control.



# ICOM IC-7610

- USB cable provides *two* virtual serial ports
- In IC-7610 **SET > Connectors > USB Send/Keying:**  
Set **USB Keying (CW)** to **USB1(A) DTR**  
Set **USB Keying (RTTY)** to **USB1(B) DTR**  
Set **USB Send** to **USB1(A) RTS** or **USB1(B) RTS**
- In Logging Software, rig control COM Port (A):  
DTR=CW, RTS=PTT
- In MMTTY, use **EXTFSK** or **ESTFSK64** to select second COM Port (B):  
FSK=DTR, PTT=RTS
- Cannot set *both* ports to use hardware PTT, so use “Software PTT” on Rig Control Port (A) if necessary.



## ICOM IC-7850, IC-7851

- USB cable provides *two* virtual serial ports
- In IC-785x **SET > Others** menu:
  - Set **USB Keying (CW)** to **USB1 DTR**
  - Set **USB Keying (RTTY)** to **USB2 DTR**
  - Set **USB Send** to **USB1 RTS (CW)** or **USB2 RTS (RTTY)**
- In Logging Software, rig control COM Port (USB1)  
set DTR=CW, RTS=PTT
- In MMTTY, use **EXTFSK** or **ESTFSK64** to select second  
COM port (USB2)  
FSK=DTR, PTT=RTS
- Cannot use *both* ports for hardware PTT, so use “Software  
PTT” on Rig Control Port (USB1) if necessary.



# Yaesu FT-991

- USB cable provides *two* Silicon Labs virtual serial ports:

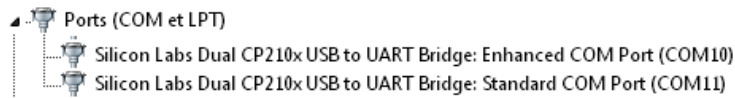

- In Yaesu Menu, set  
**030 232C TOT: 1000 msec** (default is only 10 msec)  
**033 CAT RTS: Disable** (Turns off RS232 handshaking)  
**060 PC Keying: DTR**  
**071 DATA PTT SELECT: RTS**  
**098 RTTY SHIFT PORT: DTR**  
**110 SSB PTT SELECT: RTS**
- In Logging Software, rig control is via the “Enhanced” COM Port, CW / PTT via “Standard” COM Port: DTR=CW, RTS=PTT
- In MMTTY, use **EXTFSK** or **ESTFSK64** with the “Standard” COM port: FSK=DTR, PTT=RTS





# Yaesu FTdx101D or FTdx101MP

- USB cable provides *two* Silicon Labs virtual serial ports:

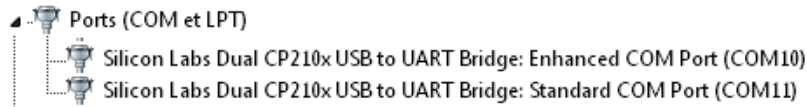

- In Yaesu Menu, set
  - OPERATION SETTING / GENERAL:  
**232C TIME OUT TIMER: 1000 msec** (default is only 10 msec)  
**CAT RTS: OFF** (Turns off RS232 handshaking)
  - RADIO SETTING / MODE SSB, RTTY, and PSK/DATA:  
**RPTT SELECT: RTS**
  - RADIO SETTING / MODE CW:  
**PC KEYING: DTR**
- In Logging Software, rig control is via the “Enhanced” COM Port, CW / PTT via “Standard” COM Port: DTR=CW, RTS=PTT
- In MMTTY, use **EXTFSK** or **ESTFSK64** with the “Standard” COM port: FSK=DTR, PTT=RTS

# Kenwood TS-890



- USB cable provides *two* Silicon Labs virtual serial ports:

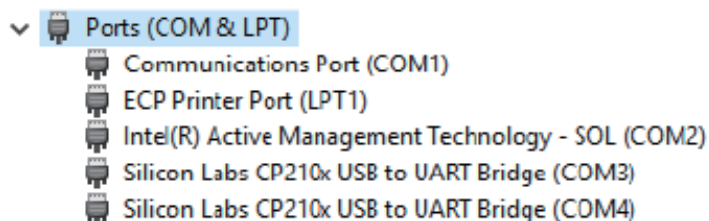

- Right click, Properties, Details tab, Location Path:  
USB1 is “Standard” Serial Port, USB2 is “Enhanced”
- In Logging Software, rig control is via the “Standard” COM Port  
CW / PTT / FSK keying may be assigned to DTR or RTS of either port
- **Menu 17 Virtual Standard COM Port RTS: PTT**  
**Menu 18 Virtual Standard COM Port DTR: CW Keying**  
**Menu 19 Virtual Enhanced COM Port RTS: PTT**  
**Menu 20 Virtual Enhanced COM Port DTR: RTTY Keying**



# N1MM+ Contest Software

- Open Configurer, view Hardware Tab
- Check CW/Other box next to Rig's Serial Port
- Click Set button

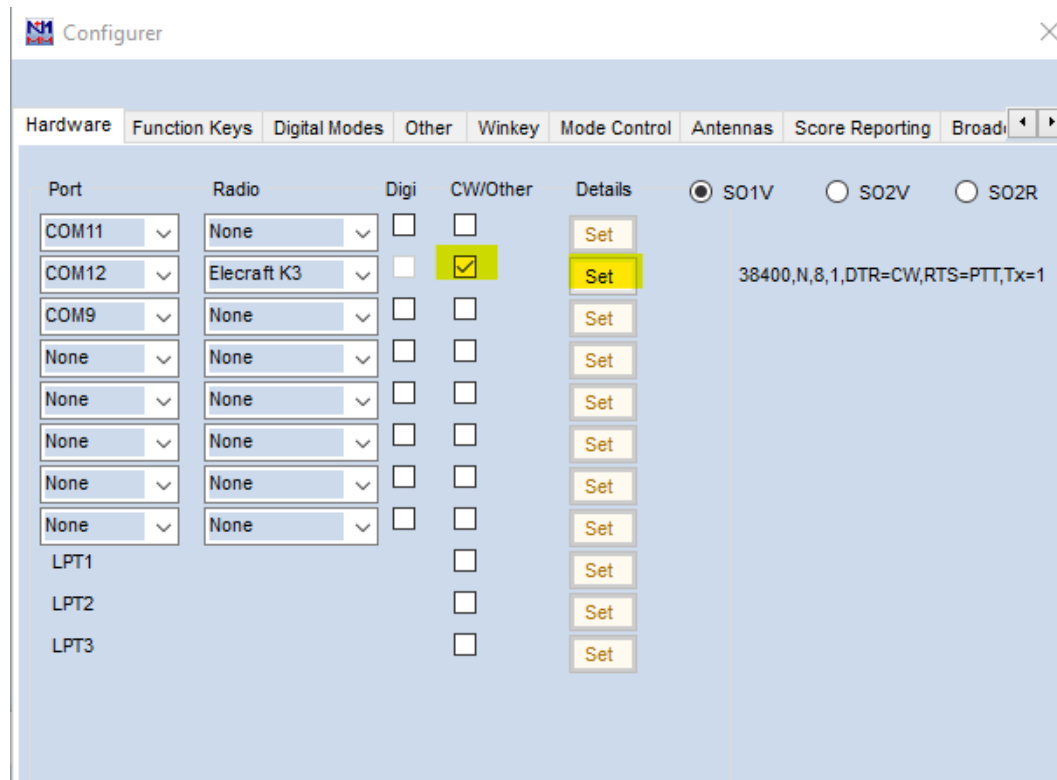

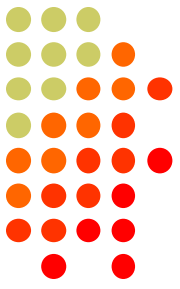

# N1MM+ Contest Software

- CW Timing over USB is usually OK!
- Set DTR (pin 4) = CW, RTS (pin 7) = PTT



Com12

Speed: 38400, Parity: N, DataBits: 8, Stop Bits: 1

DTR (pin 4): CW, RTS (pin 7): PTT, Radio Nr: 1

PTT Delay (msec): 0

Enable Both Hardware & Software PTT

PTT via Radio Command SSB Mode

PTT via Radio Command CW Mode

Allow ext interrupts  PTT via Radio Command Digital Mode

Two Radio Protocol: None, FootSwitch (pin 6): None

Radio Polling Rate: Normal

Suggested Elecraft K3 Settings:  
19200 - 38400, N, 8, 1, Always Off, Always Off

Help OK Cancel



# Win-Test Contest Software

- Set DTR (pin 4) = CW, RTS (pin 7) = PTT

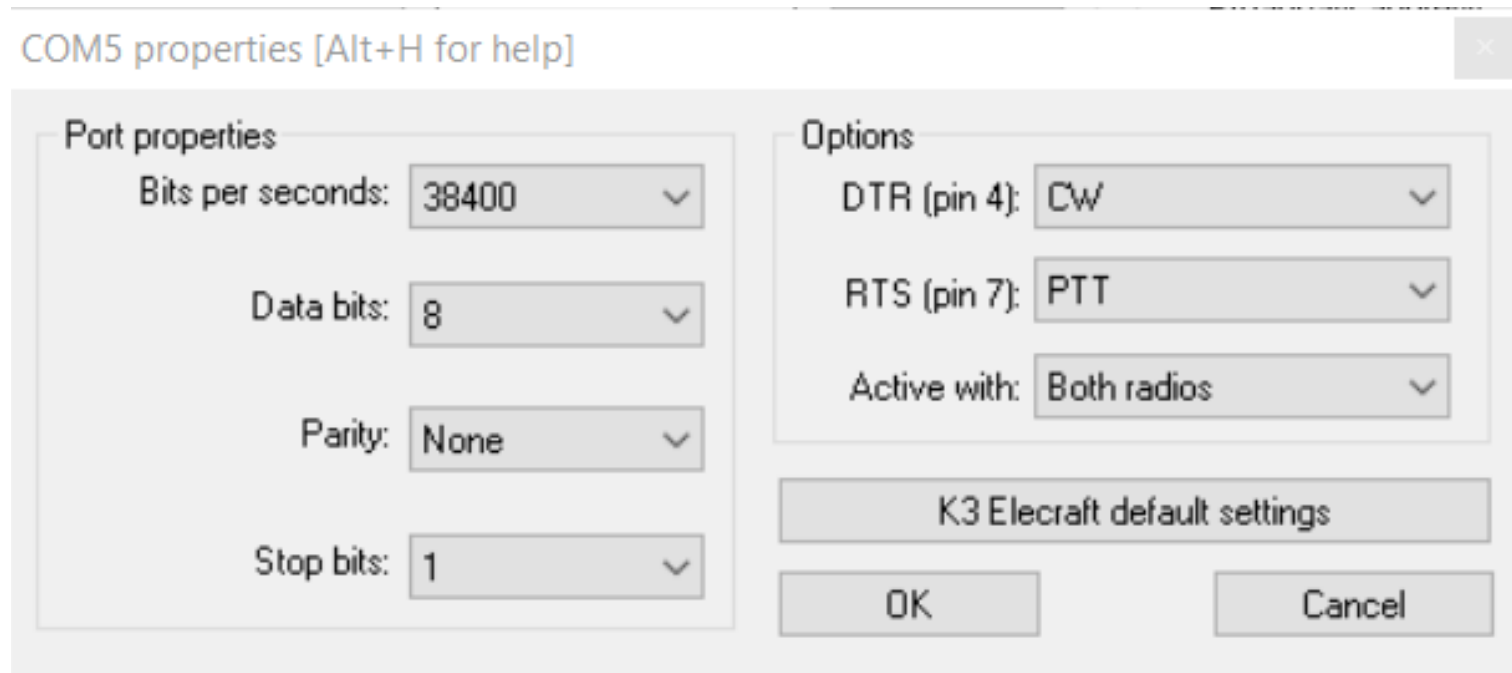



# MMTTY Setup Menu, TX Tab

- Set **Port** to **EXTFSK64**, then click **Radio Command**

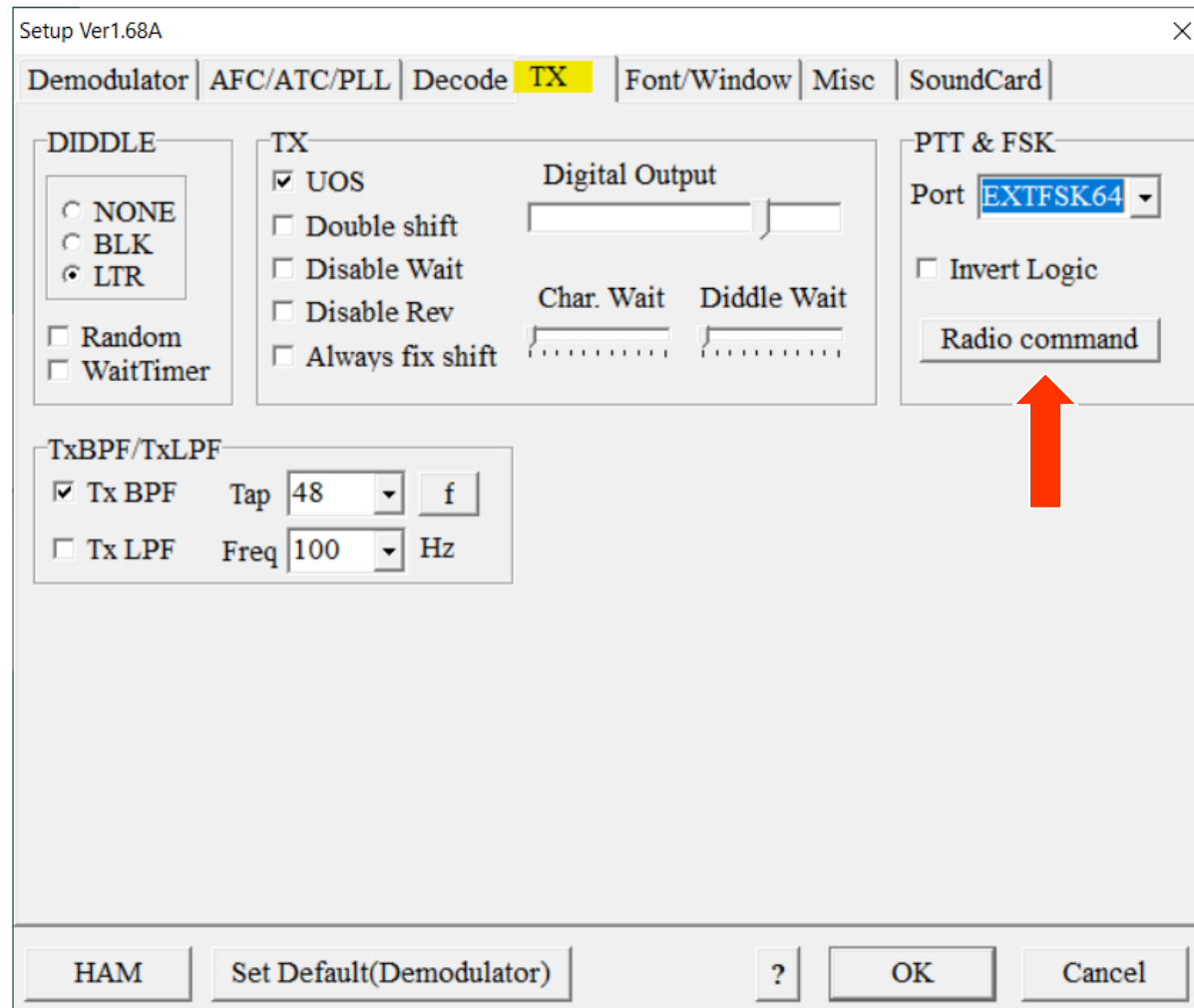



# MMTTY Setup Menu, Radio command button

- Set **Port** to **NONE**, Group to **Clear**

Radio command

Port definition

Port **NONE** Baud 57600 Char. wait 0 ms

Data length:  7bits  8bits

Stop:  1bit  2bits

Parity:  None  Even  Odd

flow control:  XON/XOFF  CTS

DTR/RTS:  PTT

Commands

Init:

Rx:

Tx:

Model: NONE Polling interval 1 secs

Frequency offset:  OFF  LSB  USB

Group **Clear** Load Save ? OK Cancel



# MMTTY Setup Menu, Misc Tab

- Set TX Port to **COM-TxD(FSK)**, click **USB Port**

Setup Ver1.68A

Demodulator | AFC/ATC/PLL | Decode | TX | Font/Window | **Misc** | SoundCard

Sound Card

FIFO  
RX 12 TX 4

Priority  
 Normal  Highest  
 Higher  Critical

Device Identifiers  
RX 0 TX 0

Source  
 Mono  Right  
 Left

Clock  
11025 Hz Adj  
0.00 Hz  
Tx offset

Sound loopback  
 OFF  
 Int.  
 Ext.(SAT)

Tx Port  
 Sound  
 Sound + COM-TxD (FSK)  
 **COM-TxD(FSK)** **USB Port**

System Font  
Window Times New Roman Set 0  
Fixed pitch Courier New Set 0  
Japanese English

HAM Set Default(Demodulator) ? OK Cancel





# MMTTY USB Port Menu

- Set Processing Method to **C: Limiting Speed**

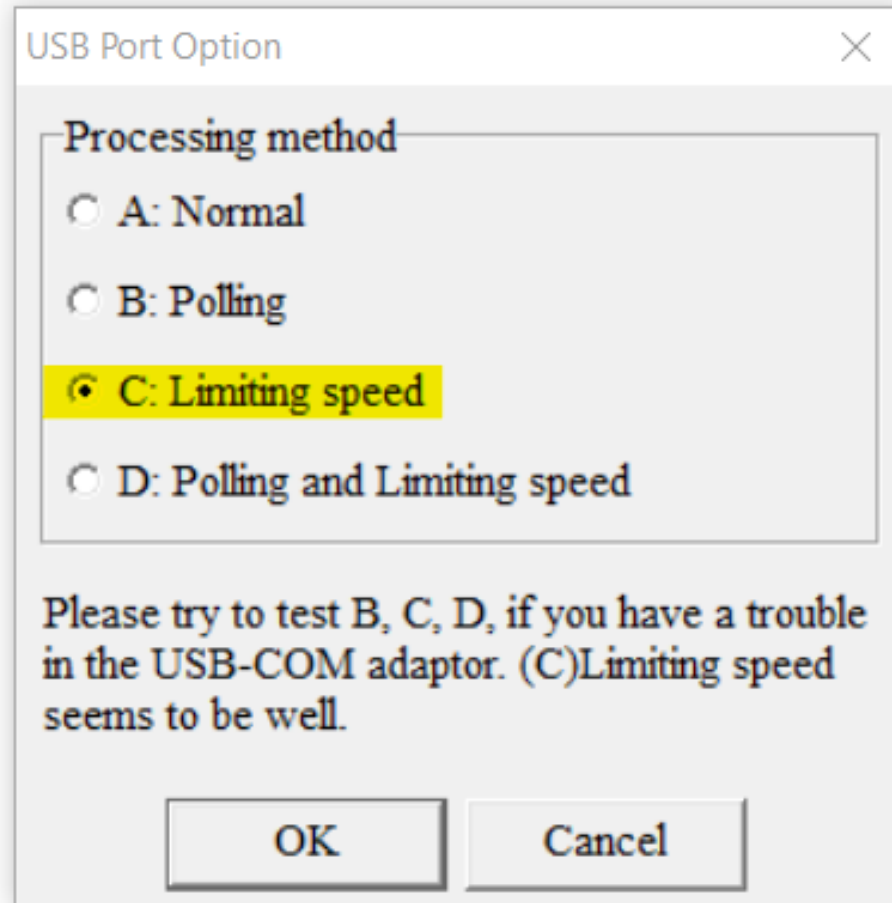



# EXTFSK Pop-Up Menu

- Select second COM Port, FSK=DTR, PTT=RTS

EXTFSK 2.0e

Port  Status:OK

FSK output

TXD

RTS

DTR

PTT output

TXD

RTS

DTR

Inv. FSK  Inv. PTT 45 baud

# Serial Port Hardware Sharing



- In RS232 protocol, only **one** TXD line (Pin 3) can be connected between a PC and a Radio
- No other device may connect to Pin 3 if a PC is connected
- PC Polls radio on Pin 3 (TXD), Radio sends response on Pin 2 (RXD).
- AUTO INFO mode provides same output without PC polling
- Multiple devices (SteppIR controllers, Band Decoders, Elecraft / ACOM / SPE amplifiers) may *monitor* the RXD line in parallel by only connecting to Pin 2.

# Shameless Plug



- The N6TV “Serial Box” (S-BOX and S-BOX-USB w/FTDI) by N6TV implements parallel connections to RXD pin via standard D-SUB cables:

<https://bit.ly/S-BOX>



- S-BOXs also provide four NPN keying circuits for rigs that do not provide RTS/DTR CW/FSK/PTT keying support, e.g. Yaesu **FTdx5000 FT-1000MP**, Kenwood **TS-990s TS-590s**, ICOM **IC-7600 IC-7700 IC-7800 ...**

# Serial Port Software Sharing



- Software sharing: multiple programs simultaneously access the radio's rig control serial port
- Implemented by VE3NEA's OmniRig software
- OmniRig may be used by Win-Test, Writelog, HDSDR, WJST-X, Log4OM, etc. for rig control
- NOT supported by N1MM+, N3FJP, others
- OmniRig owns the serial port, acts as traffic cop, no collisions or conflicts between applications
- Can I use VSPE instead? vspMgr? Maybe, but collisions / conflicts may occur
- CW / PTT / FSK Keying via OmniRig port not supported

# Radios with USB *and* DE-9 connectors



- Elecraft K3: USB and Serial Port (“P3/RS232”) do not operate independently (parallel TXD wiring)
- Elecraft K4: this limitation should be eliminated
- Kenwood TS-590S and others: USB and Serial Port operate independently
- ICOM USB and CI-V Ports (3.5mm, not DE-9) may operate independently (set **USB CI-V Port** to **Unlink from [REMOTE]**)
- Allows two devices to poll radio at same time via independent serial ports, one USB, one DE-9 or CI-V.

# USB connection to radio adds a new Windows Sound Card



- **USB Audio CODEC**
- Can be use for contest recording, voice keying, RTTY / FT8 decoding
- Multiple “USB Audio CODEC” devices, which is my radio?
- Right click on Speaker icon, then **Open Sound settings**

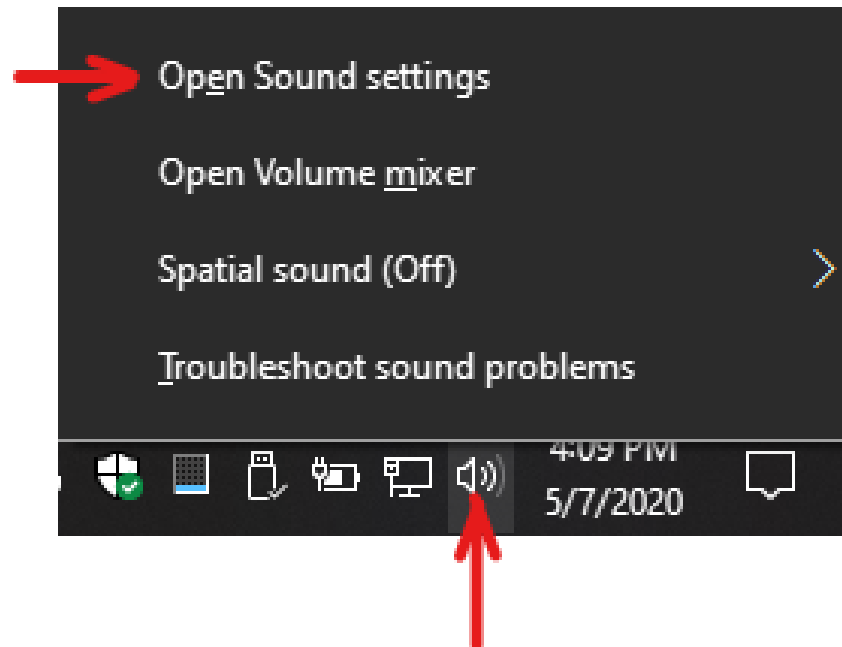



# Opening Windows Sound Control Panel

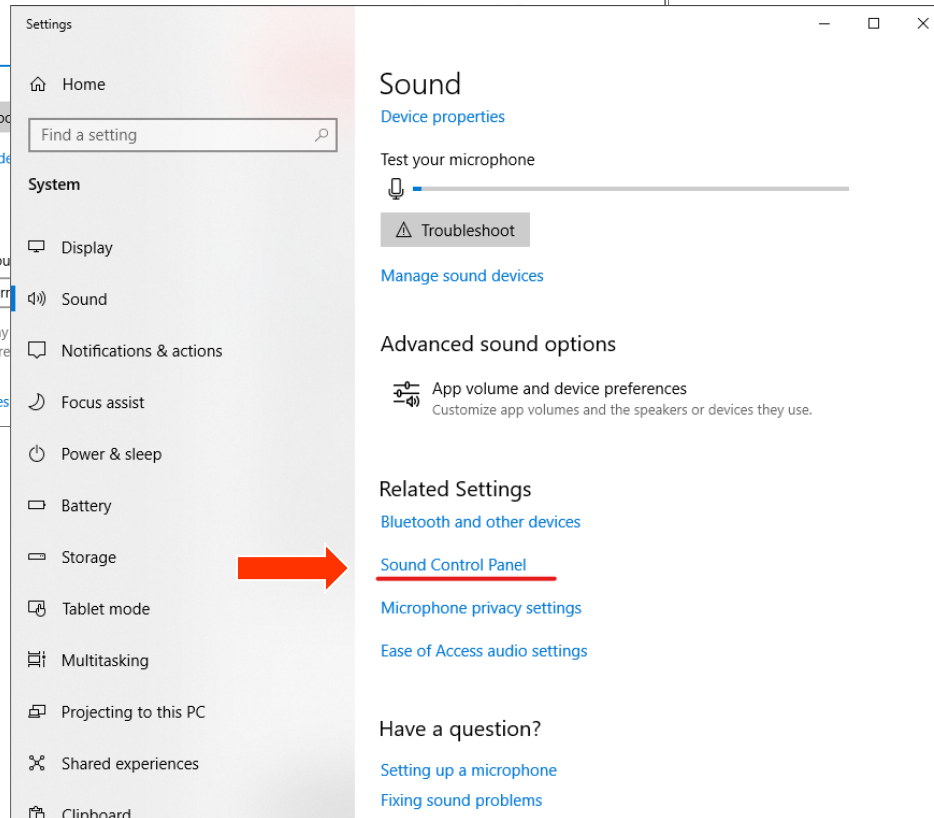
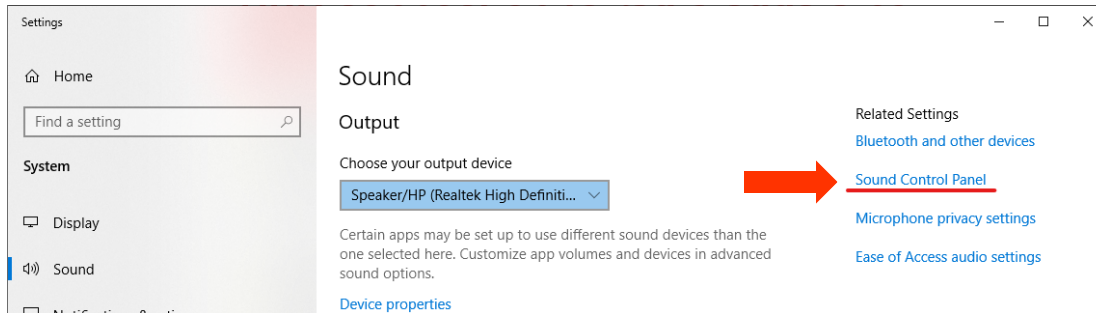

- Easier way:  
Windows Key  
+ R (run):  
**mmsys.cpl**



# Windows Sound Control Panel

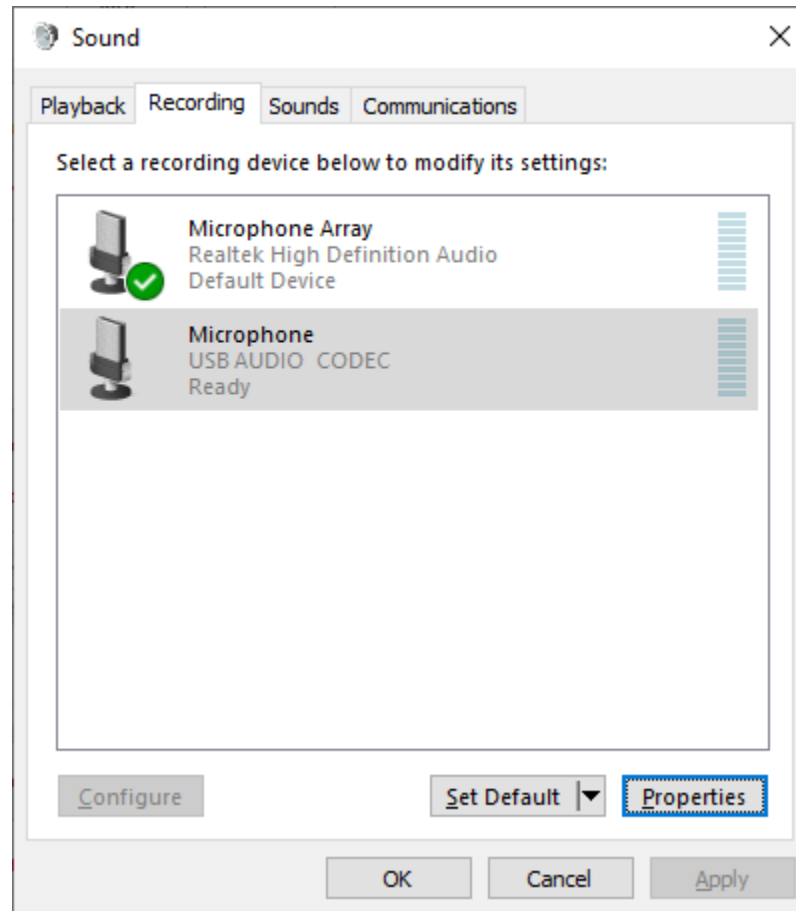
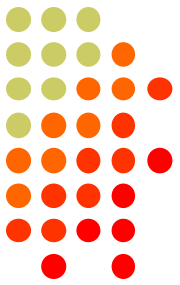



## In Sound Control Panel, which sound card?

- Watch **USB AUDIO CODEC** devices
- One will disappear and reappear when you disconnect and reconnect the USB cable from the back of the radio
- Select that device, then click **Properties** button
- Label both the **Recording** and **Playback** tabs with name of device, click **Apply**

# Labeling a USB Audio CODEC Device

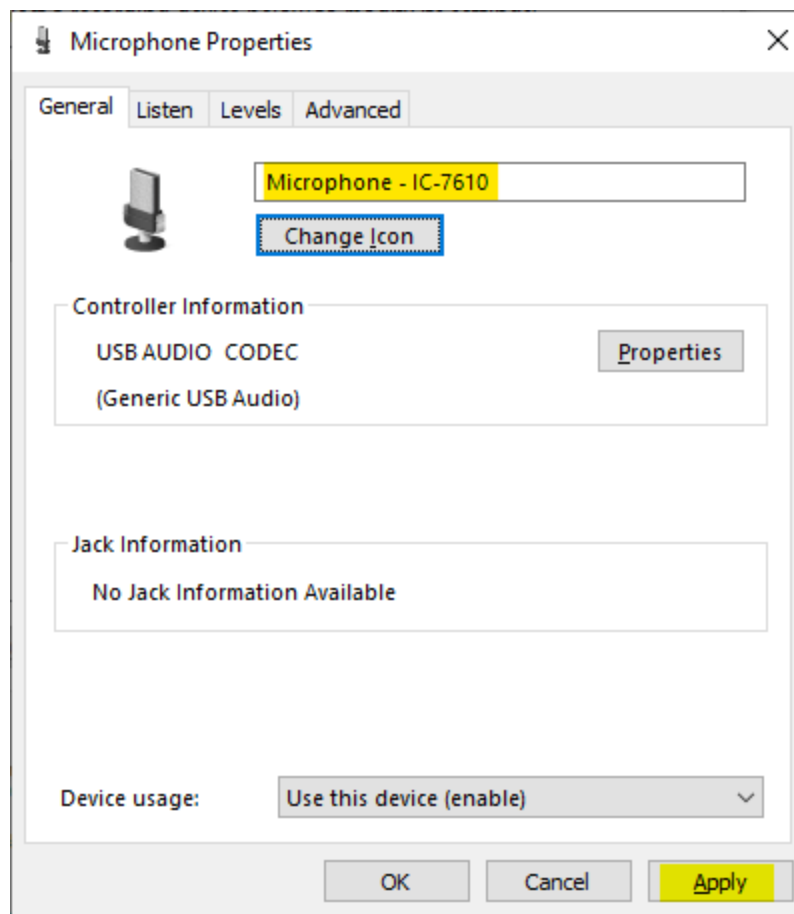

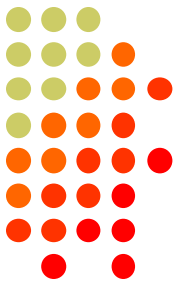

# Change Icon of USB Audio CODEC Device

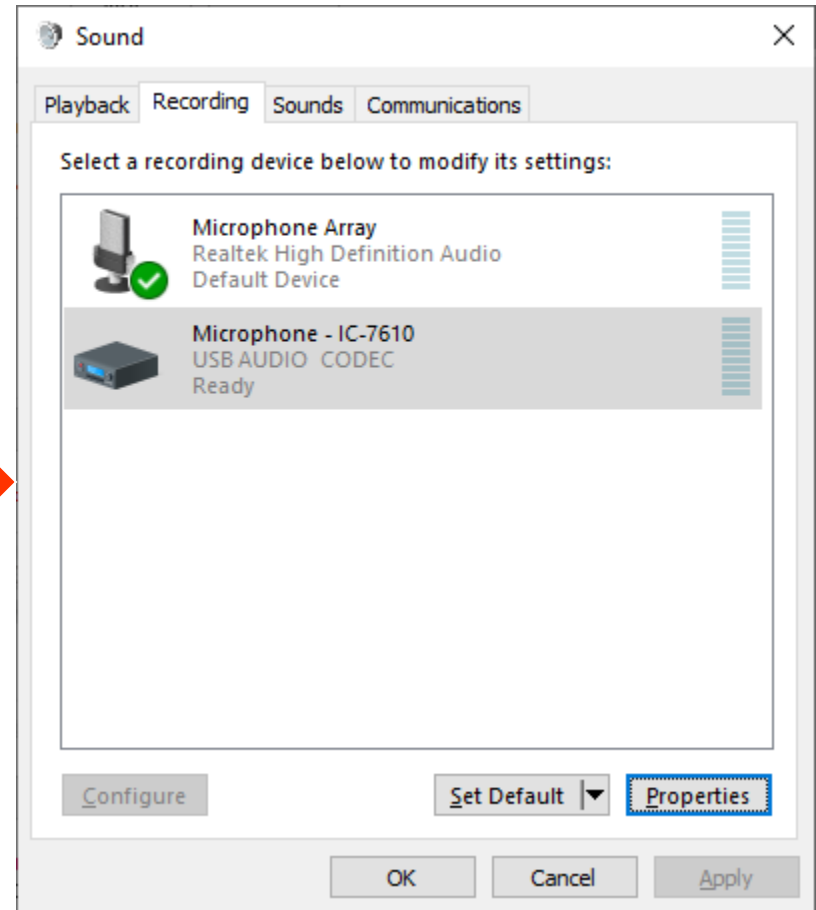
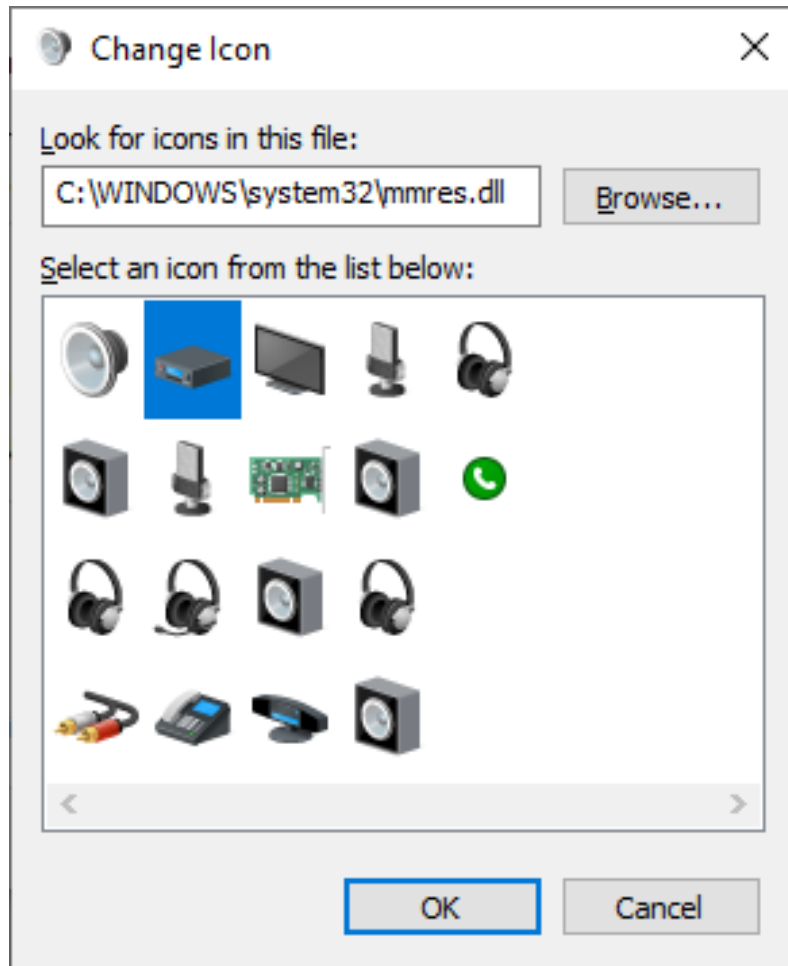

# Key Points to Remember



- (Set **devmgr\_show\_nonpresent\_devices** to 1)
- Use the Windows Device Manager to manage and renumber COM ports
- Always uninstall Prolific devices and drivers
- Always change the FTDI Default Options
- Try CW, FSK and PTT keying via serial port pins
- Use DTR for CW/FSK, RTS for PTT
- Understand serial port conflicts and sharing
- Label your USB Audio CODEC devices

# Questions?

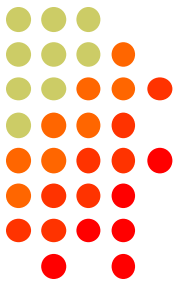

- <http://www.qrz.com/db/n6tv> - Links to this and other presentations
- [https://www.nirsoft.net/utils/usb\\_devices\\_view.html](https://www.nirsoft.net/utils/usb_devices_view.html) - USB Deview
- <https://docs.microsoft.com/en-us/sysinternals/downloads/process-explorer> - Windows Process Explorer
- <https://bit.ly/S-BOX> - The “Serial Box” by N6TV
- [n6tv@arri.net](mailto:n6tv@arri.net)